

METRISO B530

High Ohmic Resistance Tester for resistance to ground & surface resistance measurements

3-349-861-03
3/12.15



Features Overview

METRISO	B530	
Article number	M550W	
Measurements		
RES_D	U = 500 V	✓
RES_D	U = 100 V	✓
RES_D	U = 10 V	✓
R	1 Ω ... 10 kΩ	✓
U	0 ... 500 V	✓
Display Functions		
Backlit display		✓
LCD symbol for external voltage		✓
Battery level display		✓
Special Functions		
Discharge capacitive devices under test		✓
Safety shutdown (UBatt < 8 V)		✓
Features		
Measuring category CAT II 600 V		✓
Proprietary Calibration Certificate		✓

Scope of delivery

- 1 High ohmic resistance meter
- 1 Set batteries (8 ea. in battery holder)
- 1 Carrying strap
- 1 KS17-4 cable set
- 1 Alligator clip red (CAT III 1000 V)
- 1 Printed, short-form operating instructions
- 1 Supplement Safety Information
- 1 Proprietary Calibration Certificate
- Detailed operating instructions in pdf format at www.warmbier.com

Battery Compartment Lid and Location of the Fuses (housing bottom)

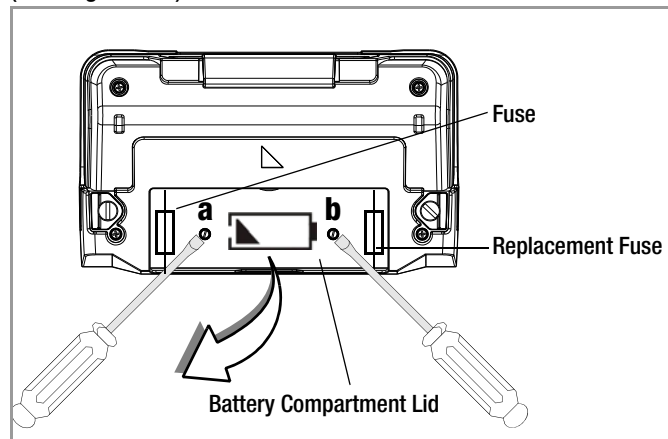

Inserting the Battery Holder (side view)

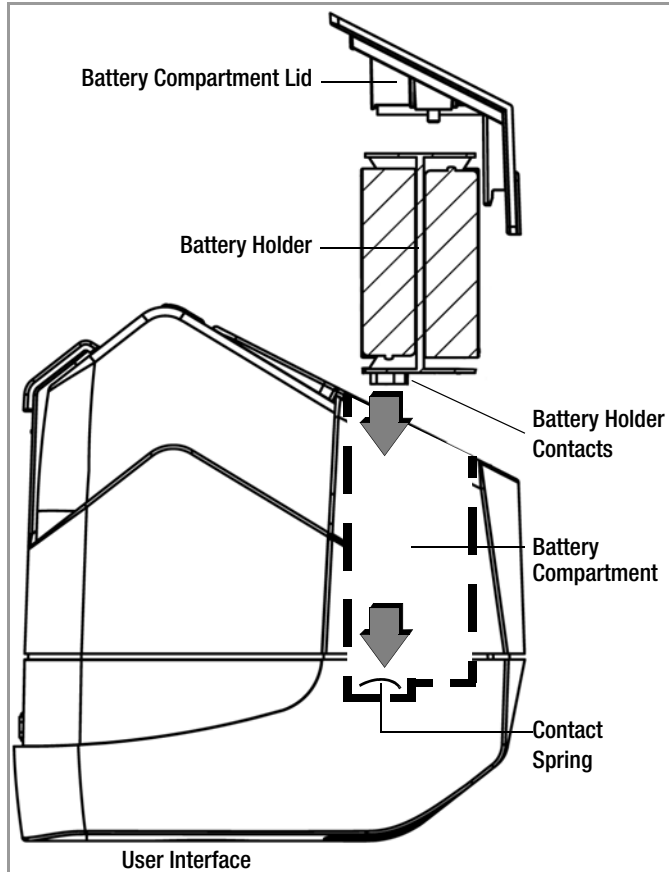

Connections (housing top)

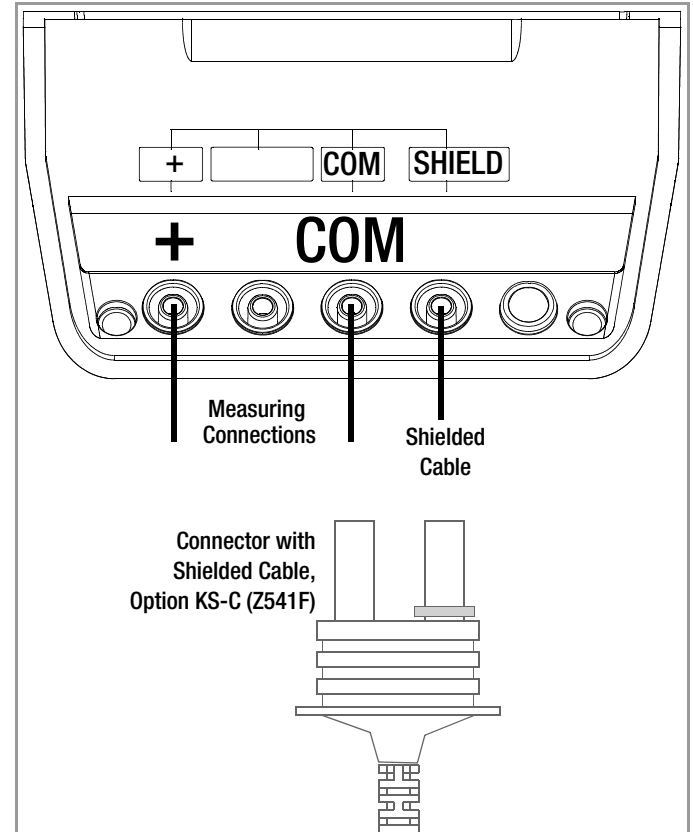

User Interface (METRISO B530)

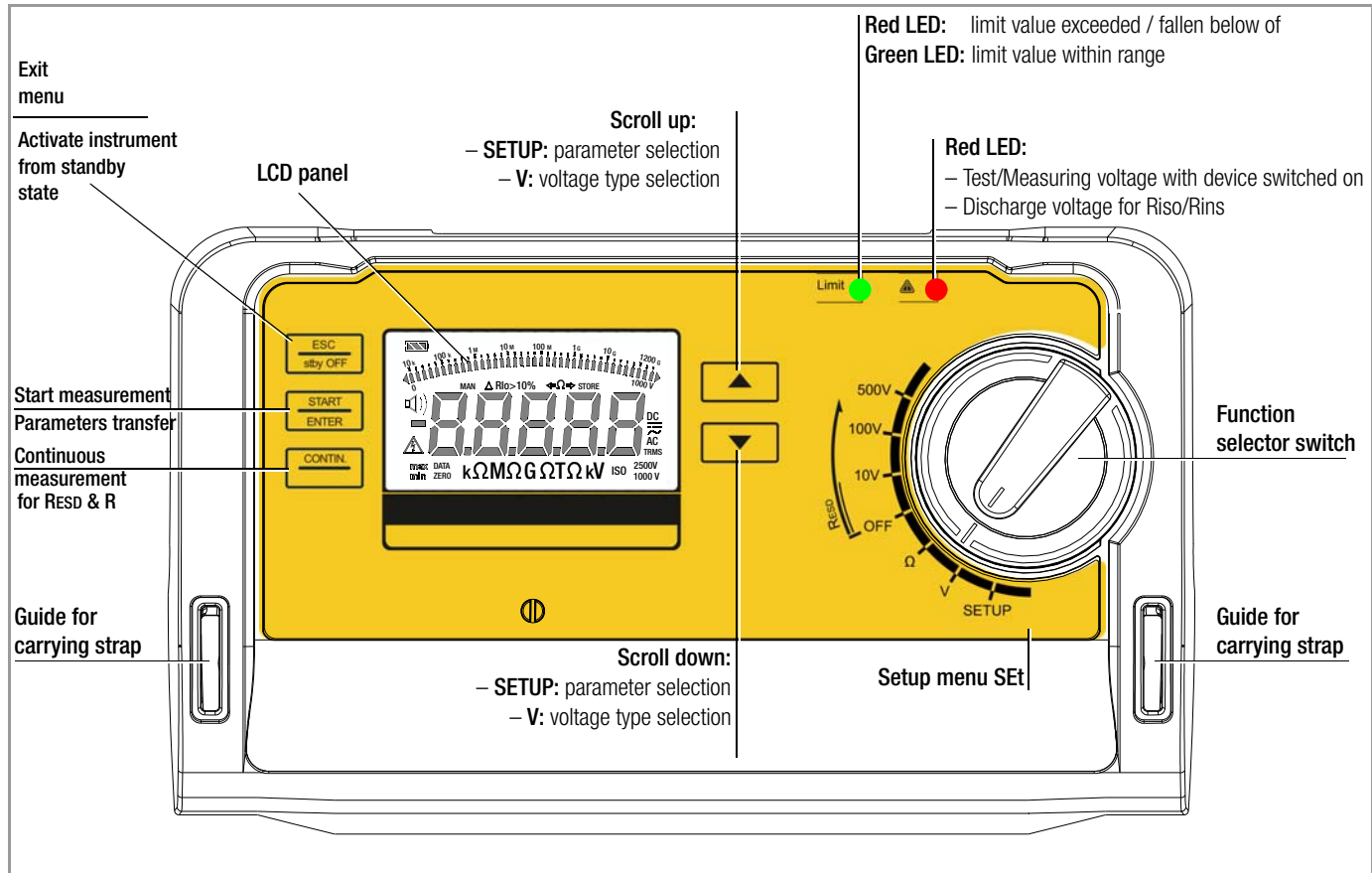

Digital Display Symbols

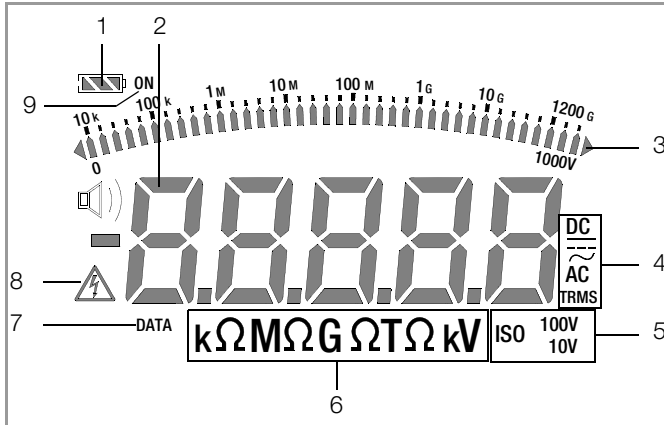

- 1 Battery level indicator
- 2 Digital display with decimal point and polarity display
- 3 Analog display pointer: bar graph or pointer, see A.diSP parameter on page 12
Triangle at display: indicates overranging
- 4 **DC/AC:** Selected current type
- 5 **ISO xxxV:** ESD measurement: selected test voltage
- 6 **Ω V:** Unit of measure
- 7 **DATA:** *Blinks* during measurement
Static: measured value is stable
- 8 Warning regarding dangerous voltage:
U > 50 V AC/DC
- 9 **ON** Instrument is continuously on (except with switch in OFF position), see APOFF parameter on page 11

Battery level indicator

- Battery full
- Battery OK
- Battery weak
- Battery (almost) dead, U < 8.5 V

Contents	Page
1 Applications	7
2 Safety Features and Precautions	8
3 Initial Start-Up	9
3.1 Battery test	9
3.2 Installing or Replacing Batteries	9
3.3 Query and Set Device Parameters – SETUP Function	10
3.3.1 Paths to the Various Parameters	10
3.3.2 Querying Parameters – InFo Menu (as moving letters)	11
3.3.3 Entering Parameters – SET Menu	11
3.3.4 Default Settings	13
4 General Operation	14
4.1 Switching On, Monitoring and Switching Off	14
4.2 Measured Value Display	15
5 ESD Measurements	16
5.1 Connection	16
5.2 Performing the Measurement	16
5.3 Ending the Measurement	17
5.4 Measuring Resistance to ground Rg or Rgp according to IEC 61340-4-1	18
5.5 Measuring Resistance through a person to ground Rg System or Rgp System .	19
5.6 Measuring Point-to-Point Resistance	20
5.6.1 Measuring Point-to-Point Resistance Rp-p with	
2 Measuring Probes according to IEC 61340-2-3	20
5.7 Measurement of Volume Resistance RV according to IEC 61340-2-3	21

Contents	Page
6 Measuring Direct, Alternating and Pulsating Voltage – V Function	22
7 Measuring Resistance – Ω Function	23
8 Characteristic Values	24
9 List of Abbreviations and their Meanings	28
10 Maintenance	28
10.1 Battery and Rechargeable Battery Operation	28
10.2 Fuses	28
10.2.1 Fuse Link – FUSE Message	28
10.2.2 Electronic Fuse	29
10.3 Housing	29
11 Appendix	30
11.1 Attaching the strap to the test instrument	30
11.2 Attaching the Test Probe Holder to the Carrying Strap	30
11.3 Technical Data for Measurement Cables (scope of delivery: KS17-4 safety cable set)	32

1 Applications

The **METRISO B530** measuring and test instrument allows quick and efficient testing of ESD protective measures in the EPA (electrostatic protected area).

The test instrument is suitable for:

- The selection of ESD materials
- Installation of selected protective measures
- Periodic inspection of protective measures

With the help of the **METRISO B530**, you can perform all relevant ESD measurements in accordance with IEC 61340-4-1, IEC 61340-2-3 and IEC 61340-4-5.

The following measurements and tests can be performed with the **METRISO B530**:

- Resistance to ground, point-to-point and surface resistance, as well as volume resistance (with special measuring probes)

2 Safety Features and Precautions

The electronic measuring and test instrument is manufactured and tested in accordance with safety regulations IEC/EN 61010-1 / VDE 0411-1. When used for its intended purpose, safety of the operator, as well as that of the instrument, is assured.

Read the operating instructions thoroughly and carefully before using your instrument. Follow all instructions contained therein.

The measuring and test instrument may not be placed into service:

- If the battery compartment lid has been removed
- If external damage is apparent
- If connector cable or measuring adapters are damaged
- If the instrument no longer functions flawlessly
- After extraordinary damage due to transport
- After long periods of storage under unfavorable conditions (e.g. humidity, dust or extreme temperature)

Opening of Equipment / Repair

The equipment may be opened only by authorized service personnel to ensure the safe and correct operation of the equipment and to keep the warranty valid.

Even original spare parts may be installed only by authorized service personnel.

In case the equipment was opened by unauthorized personnel, no warranty regarding personal safety, measurement accuracy, conformity with applicable safety measures or any consequential damage is granted by the manufacturer.

Meaning of Symbols on the Instrument



Warning concerning a source of danger (attention: observe documentation!)



Protection class II device

CAT II

Device assigned to measuring category CAT II 600 V



EC mark of conformity



The device and included batteries may not be disposed of with the trash.

3 Initial Start-Up

3.1 Battery test

Four different battery symbols, ranging from fully depleted to fully charged, continuously indicate the momentary charge level in the upper left-hand corner of the display

If battery voltage has fallen below the allowable lower limit, the pictograph shown at the right appears. The instrument does not function if the batteries have been depleted excessively, and no display appears.



3.2 Installing or Replacing Batteries

New batteries must be inserted for initial start-up, or **if only one filled segment remains in the battery symbol**.



Attention!

Before opening the battery compartment (see page 5 for location), disconnect the instrument from the measuring circuit (mains) at all poles.

Eight 1.5 V size AA batteries in accordance with IEC LR 6 are required for operation of the high-impedance measuring instrument. Use new alkaline manganese batteries only.

Rechargeable NiCd or NiMH batteries may also be used. These can only be recharged externally. We recommend rechargeable NiMH batteries.

Always replace batteries in complete sets.

Dispose of batteries in an environmentally sound fashion.

- ⇨ Loosen both slotted screws for the battery compartment lid on the back, and remove the lid.
- ⇨ Remove the battery holder and insert eight 1.5 V size AA batteries with correct polarity in accordance with the symbols.



Attention!

Make sure that all of the **batteries are inserted with correct polarity**. If just one battery is inserted with reversed polarity, it will not be recognized by the instrument and may result in leakage from the batteries.

- ⇨ Push the battery holder into the battery compartment such that the battery holder's contacts touch the contact springs at the bottom of the battery compartment (see drawing on page 3).
If the battery holder is not inserted as specified, the instrument cannot be supplied with power.
- ⇨ Replace the battery compartment lid and retighten the screws.



Attention!

The instrument may only be placed into service if the battery compartment lid is securely fastened!

3.3 Query and Set Device Parameters – SETUP Function

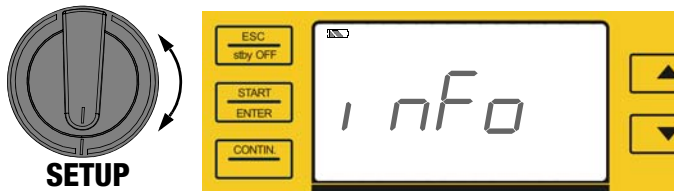

- ⇨ Turn the rotary switch to the **SETUP** position.
- Info* appears at the display.
- ⇨ Press **ENTER** to query battery voltage or firmware version.
- ⇨ Then select the desired operating parameters with the scroll keys and acknowledge by pressing the **ENTER** key.

The desired information is displayed in the scroll mode (moving letters).

3.3.1 Paths to the Various Parameters

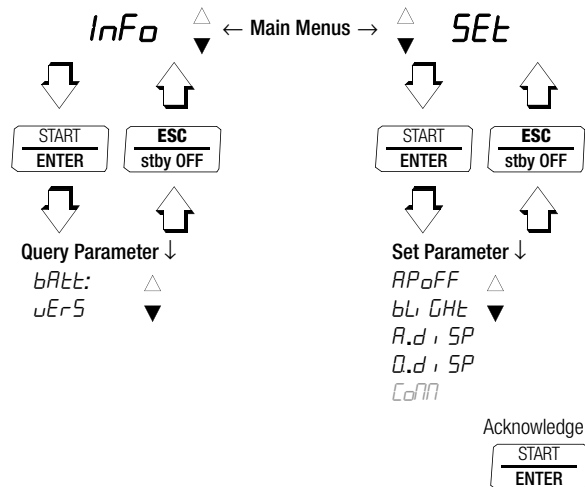

List of all parameters (alphabetical order)

Parameter	Page: Header
<i>0.d</i> , <i>SP</i>	12: 0.diSP – Show/Hide Leading Zeros
<i>A.d</i> , <i>SP</i>	12: A.diSP – Analog Display: Select Display Mode
<i>APoFF</i>	11: APoFF – Specified Time for Automatic Shutdown and Continuous ON
<i>bAtt</i>	11: bAtt – Query Battery Voltage
<i>bLi</i> , <i>GLt</i>	11: bLiGt – Switching LCD Illumination On/Off
<i>CoN</i>	For service purposes only
<i>Info</i>	11: Querying Parameters – InFo Menu (as moving letters)
<i>SEt</i>	11: Entering Parameters – SEt Menu
<i>vErSion</i> , <i>on</i>	11: vErSion – Query Firmware Version

3.3.2 Querying Parameters – InFo Menu (as moving letters)

bAtt – Query Battery Voltage

Info  *bAtt: 12.05 V.*

vErSion – Query Firmware Version

Info  *bAtt: ▽ vErSion: 0 1.03.04*

3.3.3 Entering Parameters – SEt Menu



APoFF – Specified Time for Automatic Shutdown and Continuous ON

Shutdown time *APoFF* can be specified with this parameter. The instrument is switched off automatically if the measured value remains unchanged for a long period of time and if none of the keys or the rotary switch have been activated before specified *APoFF* time (entered in minutes) has elapsed.

The selected on-time has as substantial influence on battery service life.

If the *on* setting is selected, the instrument is set for long-term measurement and **ON** appears at the display to the right of the battery symbol. In this case, the instrument can only be switched off manually.

Info ▽ *SEt*  *rLEAd* ▽ ... ▽ *APoFF*



 *10 ... 59 min on* ▽ ▽ 

(10 minutes = default setting)

bLiGt – Switching LCD Illumination On/Off

Automatic deactivation of display illumination after xx seconds (after the last time the rotary switch is actuated) can be selected in order to extend the battery service life. As soon as a new measuring function is selected or started, illumination is reactivated. When set to *oFF*, illumination is permanently deactivated.

Info ▽ *SEt*  *rLEAd* ▽ ... ▽ *bLi* *GLt*

 *15 / 30 / 45 / 90 s oFF* ▽ ▽ 

(15 seconds = default setting)

A.diSP – Analog Display: Select Display Mode

One of two different display modes can be selected for the analog display:

- *barG*: bar graph
- *Point*: pointer

Info ▾ *SEt*  *rLEAd* ▾ ... ▾ *R.d, SP*

 *barG / Point* ▾ ▾ 

(*Point* = default setting)

0.diSP – Show/Hide Leading Zeros

This parameter determines whether or not leading zeros will appear in the measured value display.

Info ▾ *SEt*  *rLEAd* ▾ ... ▾ *0.d, SP* 

0000.0: with leading zeros (default value)

0.0: leading zeros suppressed

△ ▾ 

3.3.4 Default Settings

Previously entered changes can be undone, and default settings can be restored. This may be advisable under the following circumstances:

- After the occurrence of software or hardware errors
- If you are under the impression that the instrument does not work correctly
- ⇨ Disconnect the device from the measuring circuit.
- ⇨ Briefly remove the batteries (see also section 3.2).
- ⇨ Press and hold the  key,
and reinsert the batteries.

After hearing two acoustic signals, the instrument has been restored to its default settings.

4 General Operation

The test leads are connected to the “+” and “COM / SHIELD” jacks.

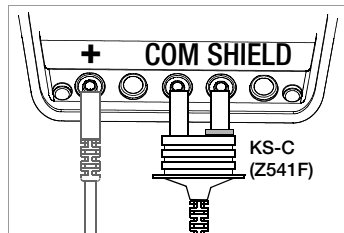

4.1 Switching On, Monitoring and Switching Off

If battery voltage falls below the allowable limit value ($U < 8\text{ V}$) the instrument cannot be switched on, or it is immediately switched off.





Measurement cannot be started in the resistance measuring ranges in the event of external voltage.

The instrument only switches itself off automatically after completion of an automatic measuring sequence, and after the predetermined on-time has expired (APOFF parameter in SETUP switch position, see page 11). On-time is reset to its original value as defined in the setup menu, as soon as any key or the rotary function switch is activated.

If the instrument is switched off automatically with the rotary switch in any position other than OFF, it can be reactivated by pressing the **stby OFF** key.

The instrument can be switched off manually by turning the rotary switch to the OFF position.

Optical Indicators

LED	Status	Function – Cause
	Limit Green	Measuring range observed – $U_{ESD} = 10\text{ V}$, $R_{ESD} < 1\text{ M}\Omega$ Measuring range observed – $U_{ESD} = 100\text{ V}$, $R_{ESD} > 1\text{ M}\Omega$
	Limit Red	Measuring range exceeded – $U_{ESD} = 10\text{ V}$, $R_{ESD} > 1\text{ M}\Omega$ Measuring range fallen below of – $U_{ESD} = 100\text{ V}$, $R_{ESD} < 1\text{ M}\Omega$
	 Red	External voltage when on and during discharge ² Dangerous voltage of greater than 50 V is present at the measurement inputs: – Initialization of the resistance measurement is disabled. – The discharging cycle has not yet been completed, e.g. residual voltage at capacitive devices under test Test/Measuring voltage with device switched on Dangerous voltage of greater than 50 V is present at the measurement inputs.
LCD	Status	Functions
	Display	External voltage when off, and during discharge Dangerous voltage of greater than 50 V is present at the measurement inputs: – Initialization of the resistance measurement is disabled. – Test voltage applied during insulation measurement – The discharging cycle has not yet been completed, e.g. residual voltage at capacitive devices under test

² Function testing should be executed regularly (see following section on testing LEDs).

4.2 Measured Value Display

The following appear at the LCD panel:

- Measured value in digital format
- Measured value in analog format as bar graph or pointer
- Unit of measure

Measured values for automatic measuring sequences are retained at the display as digital values until the next measurement sequence is started, or until automatic shut-off occurs.

If the upper range limit is exceeded, **OL** appears at the display, thus indicating overranging.

If the lower range limit is fallen below of, **UR** appears at the display, thus indicating underranging.

Either a bar graph or a pointer can be selected for the analog display (see **AdiSP** parameter on page 12).

5 ESD Measurements

5.1 Connection



Note

Checking the Measurement Cables

Before performing resistance measurement, the test probes on the measurement cables should be short-circuited in order to assure that the instrument displays a value very close to 0Ω (see section 8). This serves to prevent faulty connections or to identify any interruptions in the measuring cables.

The **fuse link is checked** for this instrument (in all resistance measuring ranges) prior to each measurement.

- Connect the device under test to the + and **COM / SHIELD** jacks.

Wiring examples for the ESD measurement are included in section 5.4 through section 5.7.

Insulation resistance can only be measured at voltage-free objects. If mains voltage or external voltage is applied to the measurement inputs, measurement cannot be started. This is indicated by the **high-voltage symbol** which appears at the display.

5.2 Performing the Measurement

Note: Condensation must be ruled out when performing measurements at close to the freezing point.

- Select the measuring function and the desired test voltage with the rotary switch, e.g. $R_{ESD} 100V$.

The momentarily selected test voltage (nominal voltage) appears in the bottom right-hand corner of the display.

- Start an individual measurement by briefly pressing the **START** key, or initiate continuous measurement by briefly pressing the **CONTIN** key.

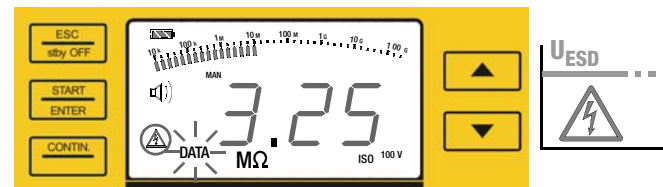
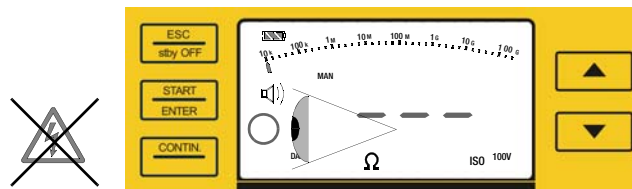
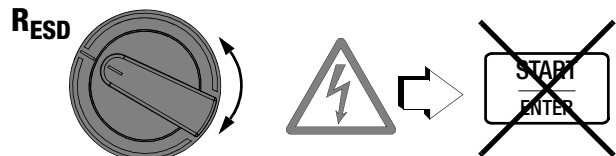

DATA blinks at the display until the measured value has settled in.



Attention!

Do not touch the instrument's terminal contacts during resistance measurements!

If nothing has been connected to the terminal contacts, or if a resistive load component has been connected for measurement, your body would be exposed to a current of approximately 1 mA

at a voltage of 500 V. The resulting electrical shock is not life endangering. However, the noticeable shock may lead to injury (e.g. resulting from a startled reaction etc.).



Note

The instrument's batteries are exposed to excessive stress during ESD resistance measurement. For this reason it's advisable to perform individual rather than continuous measurements.

5.3 Ending the Measurement

Individual measurement: Measurement is ended automatically as soon as the measured value has settled in.

Continuous measurement is ended by briefly pressing the **ESC** key.

In either case, the measured value is retained at the 7-segment display. When discharging begins, the unit of measure for the bar graph changes from Ω to V. The length of the bar graph is continuously reduced as voltage at the device under test drops.

Special Case: Capacitive Devices Under Test



Caution!

If measurement is performed at a capacitive object such as a long cable, it becomes charged with up to approx. 500 V (test voltage)! Touching such objects is life endangering!

When an resistance measurement has been performed on a capacitive object it is automatically discharged by the instrument. Contact between the object and the instrument must nevertheless not be interrupted. Do not disconnect until:

- The **caution LED (> 50 V)** is no longer illuminated
- The **high-voltage symbol** is no longer displayed
- The analog **bar graph** has dropped to a value of less than 50 V

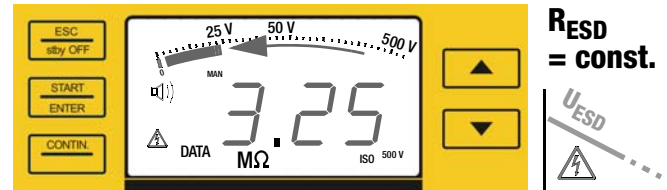

5.4 Measuring Resistance to ground R_g or R_{gp} according to IEC 61340-4-1

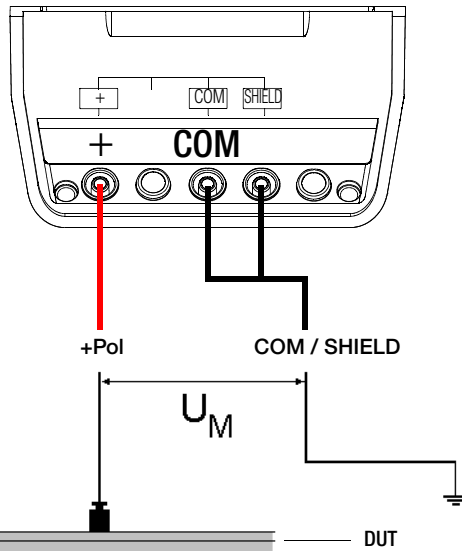

(e.g. for measuring flooring systems, table mats, chairs etc.)

- Connect the red measurement cable from the “+ Pole” to the measuring electrode.
- The black, shielded measurement cable with the double “COM / SHIELD” connectors is connected to protective earth when measuring R_g , or to a groundable point when measuring R_{gp} .



Note

Use only the 2-pole measurement cable.

- Select a measuring voltage of $U_M = 10 \text{ V}$ in the **RES** switch position. If a value of less than $1 \text{ M}\Omega$ is displayed, this value is the result.
- If the resistance to ground $\text{Resd} \geq 1 \text{ M}\Omega$ is displayed with the 10 V measuring voltage, the 100 V measuring voltage must be selected. The value which is then displayed is the result.

Measurement according to IEC 61340-4-1 Ed. 2.0:

Resd in Ω	Measuring Voltage (open-circuit voltage)
$\text{Resd} < 1 \times 10^6$	$10 \text{ V} \pm 0.5 \text{ V}$
$10^6 \leq \text{Resd} \leq 10^{11}$	$100 \text{ V} \pm 5 \text{ V}$

5.5 Measuring Resistance through a person to ground $R_{g \text{ System}}$ or $R_{gp \text{ System}}$

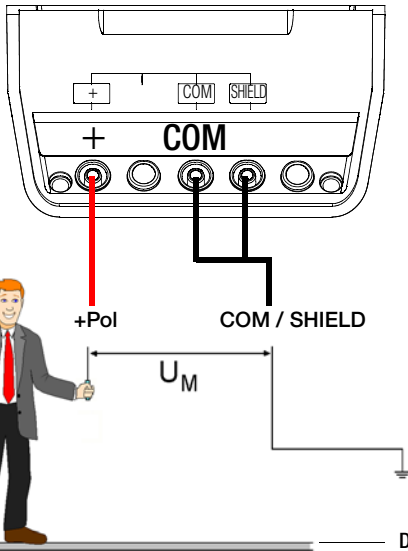

(e.g. for the measurement of a resistance through the combination of a person/shoes/flooring system according to IEC 61340-4-5)

- Connect the red measurement cable from the “+ Pole” to the measuring electrode.
- The black, shielded measurement cable with the double “COM / SHIELD” connectors is connected to protective earth when measuring $R_{g \text{ System}}$, or to a groundable point when measuring $R_{gp \text{ System}}$.



Note

Use only the 2-pole measurement cable.

- Select a measuring voltage of $U_M = 10 \text{ V}$ in the Resd switch position. If a value of less than $1 \text{ M}\Omega$ is displayed, this value is the result.
- If resistance of a person $\text{Resd} > 1 \text{ M}\Omega$ is displayed with the 10 V measuring voltage, the 100 V measuring voltage should be selected. The value which is then displayed is the result

Measurement according to IEC 61340-4-5

Resd in Ω	Measuring Voltage (open-circuit voltage)
$\text{Resd} < 1 \times 10^6$	$10 \text{ V} \pm 0.5 \text{ V}$
$\text{Resd} \geq 1 \times 10^6$	$100 \text{ V} \pm 5 \text{ V}$

5.6 Measuring Point-to-Point Resistance

5.6.1 Measuring Point-to-Point Resistance R_{p-p} with 2 Measuring Probes according to IEC 61340-2-3

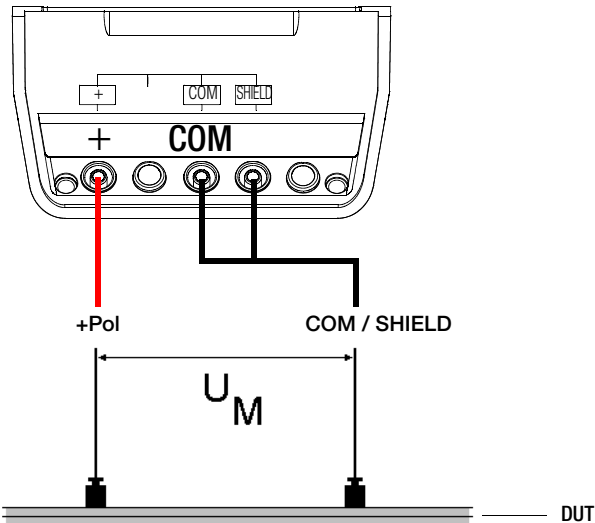
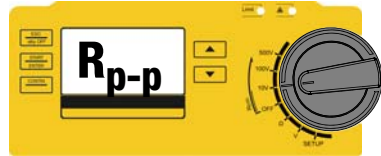

(e.g. for measuring the surfaces of workstations, trays, transport containers etc.)

- Connect the red measurement cable from the “+ Pole” to one measuring electrode and the black, shielded measurement cable with the double “COM / SHIELD” connectors to the other electrode.



Note

Use only the 2-pole measurement cable.

- Select a measuring voltage of $U_M = 10 \text{ V}$ in the Resd switch position. If a value of less than $1 \text{ M}\Omega$ is displayed, this value is the result.
- If surface resistance $\text{Resd} \geq 1 \text{ M}\Omega$ is displayed with the 10 V measuring voltage, the 100 V measuring voltage must be selected. The value which is then displayed is the result

Measurement according to IEC 61340-2-3

Resd in Ω	Measuring Voltage (open-circuit voltage)
$\text{Resd} < 1 \times 10^6$	$10 \text{ V} \pm 0.5 \text{ V}$
$\text{Resd} \geq 1 \times 10^6$	$100 \text{ V} \pm 5 \text{ V}$

5.7 Measurement of Volume Resistance R_V according to IEC 61340-2-3

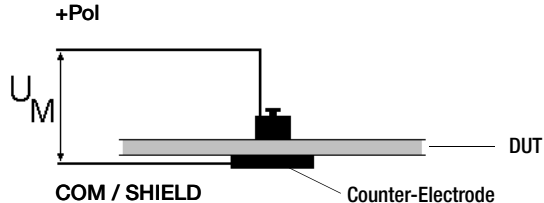

(e.g. for determining the volume resistance of a material)

- ⇨ Connect the red measurement cable from the “+ Pole” to the measuring electrode and the black, shielded measurement cable with the double “COM / SHIELD” connectors to the counter-electrode.
- ⇨ Select a measuring voltage of $U_M = 10 \text{ V}$ in the Resd switch position. If a value of less than $1 \text{ M}\Omega$ is displayed, this value is the result.
- ⇨ If volume resistance $\text{Resd} \geq 1 \text{ M}\Omega$ is displayed with the 10 V measuring voltage, the 100 V measuring voltage must be selected. The value which is then displayed is the result

Measurement according to IEC 61340-2-3

Resd in Ω	Measuring Voltage (open-circuit voltage)
$\text{Resd} < 1 \times 10^6$	$10 \text{ V} \pm 0.5 \text{ V}$
$\text{Resd} \geq 1 \times 10^6$	$100 \text{ V} \pm 5 \text{ V}$

6 Measuring Direct, Alternating and Pulsating Voltage – V Function

You can measure direct voltage, as well as sinusoidal alternating voltage with frequencies ranging from 45 to 65 Hz with this test instrument.

- Select the V measuring function with the rotary switch.
- Select the desired voltage type with the scroll keys: direct voltage (DC), alternating voltage (AC TRMS) or pulsating voltage (DC + AC TRMS)
- Connect the measurement cables to the + and **COM** jacks.
- Contact the measuring point with both test probes.

The measured value is displayed directly (without pressing the **START** key) in analog format at the bar graph and in digital format at the 7-segment display.

- After completing the measurement, switch the instrument off by turning the rotary switch to the **OFF** position.

The **ESC**, **START** and **CONTIN.** keys are disabled in this case.



Note

Input impedance for the voltage measuring range is 10 M Ω .

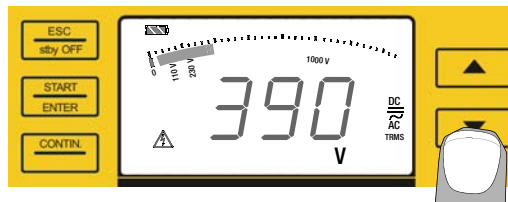
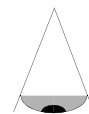
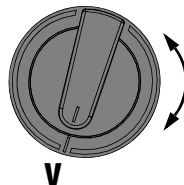
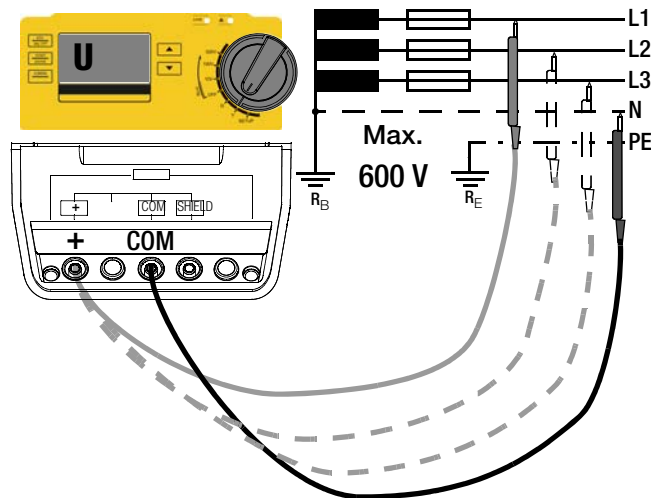

7 Measuring Resistance – Ω Function

- Connect the device under test to the + and **COM** jacks.

Resistance can only be measured at voltage-free objects. If mains voltage or external voltage is applied to the measurement inputs, measurement cannot be started.

This is indicated by the **high-voltage symbol** which appears at the display.

- Select measuring function Ω with the rotary switch.
- Start an individual measurement by briefly pressing the **START** key, or initiate continuous measurement by briefly pressing the **CONTIN** key.

DATA blinks at the display until the measured value has settled in.

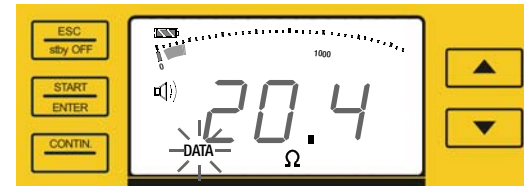
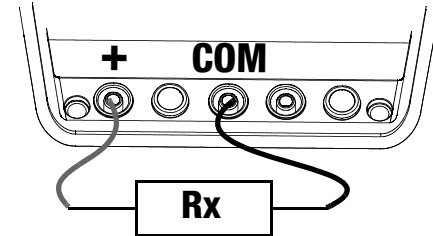
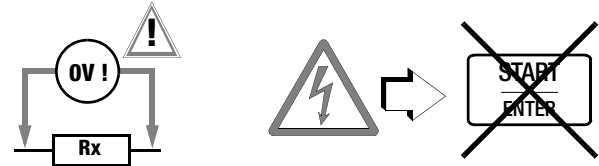
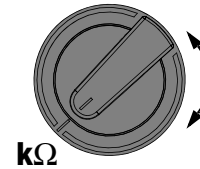

8 Characteristic Values

Meas. Qty.	U_M^2		Range	Measuring Range	Resolution	Intrinsic Uncertainty ¹	Measuring Uncertainty	Overload Capacity
RES D	10 V ³	500 V 3	10 k Ω	1,0 k Ω ... 9,99 k Ω	0,01 k	$\pm(5\% \text{ rdg.} + 10 \text{ d})$	$\pm(7\% \text{ rdg.} + 10 \text{ d})$	500 V AC/DC TRMS
			100 k Ω	10,0 k Ω ... 99,9 k Ω	0,1 k	$\pm(5\% \text{ rdg.} + 3 \text{ d})^5$	$\pm(7\% \text{ rdg.} + 3 \text{ d})$	
			1 M Ω ⁴	100 k Ω ... 999 k Ω	1 k	$\pm(5\% \text{ rdg.} + 3 \text{ d})$	$\pm(7\% \text{ rdg.} + 3 \text{ d})$	
			10 M Ω	1,00 M Ω ... 9,99 M Ω	10 k	$\pm(5\% \text{ rdg.} + 3 \text{ d})$	$\pm(7\% \text{ rdg.} + 3 \text{ d})$	
			100 M Ω	10,0 M Ω ... 99,9 M Ω	100 k	$\pm(5\% \text{ rdg.} + 3 \text{ d})$	$\pm(7\% \text{ rdg.} + 3 \text{ d})$	
			1 G Ω	100 M Ω ... 999 M Ω	1 M	$\pm(5\% \text{ rdg.} + 3 \text{ d})$	$\pm(7\% \text{ rdg.} + 3 \text{ d})$	
			10 G Ω	1,00 G Ω ... 9,99 G Ω	10 M	$\pm(5\% \text{ rdg.} + 3 \text{ d})$	$\pm(10\% \text{ rdg.} + 3 \text{ d})$	
			100 G Ω	10,0 G Ω ... 99,9 G Ω	100 M	$\pm(8\% \text{ rdg.} + 3 \text{ d})$	$\pm(10\% \text{ rdg.} + 3 \text{ d})$	
200 G Ω	100 G Ω ... 199 G Ω	1 G	$\pm(15\% \text{ rdg.} + 5 \text{ d})$	$\pm(25\% \text{ rdg.} + 20 \text{ d})$				
U AC/DC			100 V	10,0 V ... 99,9 V	0,1 V	$\pm(2,5\% \text{ rdg.} + 3 \text{ d})$	$\pm(5\% \text{ rdg.} + 3 \text{ d})$	500 V AC/DC TRMS
			500 V	100 V ... 499 V	1 V			
R	Display range as of 01,0 Ω		100 Ω	1,0 ... 99,9 Ω	0,1 Ω	$\pm(2,5\% \text{ rdg.} + 3 \text{ d})$	$\pm(5\% \text{ rdg.} + 3 \text{ d})$	500 V AC/DC TRMS
			1 k Ω	100 ... 999 Ω	1 Ω			
			10 k Ω	1,00 ... 9,99 k Ω	10 Ω			

¹ With the included, shielded, high-impedance measurement cables

² DC measuring voltage $U_M \pm 5\%$

³ See figure 1 on page 27

⁴ stable as from 200 k Ω U_M , see figure 1 on page 27

⁵ U_M 10 V: +7 digit

Reference Conditions

Reference temperature	+ 23 °C ±3 K
Relative humidity	40 ... 75%
Measured quantity frequency	45 Hz ... 65 Hz
Measured quantity waveform	Sine, deviation between TRMS and rectified value < 1%
Battery voltage	9.5 V ±0.1 V

Electrical Safety

Standard	
VDE regulation	VDE 0411, part 1, 2011
Protection class	II
Pollution degree	2
Measuring category	CAT II 600 V
Fuses	
Fuse link	FF315mA/1000V, effective in all resistance measuring ranges, 1 additional replacement fuse in the battery compartment
Elektronic fuse	for protecting resistance measurement R

Power Supply

Batteries	8 ea. 1.5 V mignon cells (8 ea. size AA) (alkaline manganese per IEC LR14) or 8 rechargeable NiMH batteries (must be recharged externally)
Nominal range of use	8.5 ... 12 V
Battery test	Battery capacity display with battery symbol in 4 segments:  . Querying of momentary battery voltage via menu function.
Battery saver circuit	Automatic shutdown of display illumination after 15 second s (after the last time the rotary switch is actuated) can be set via the <i>bL</i> , <i>GHE</i> parameter. The test instrument is automatically switched to the standby mode* when the measured value remains unchanged and none of the controls are activated during this time. * Specified time " <i>APoFF</i> " (entered in minutes) adjustable via SETUP menu (default setting approx. 10 min).
Service life	For RESD (1000 V / 1 MΩ) with 20 second on-time and 1 measurement each for a duration of 5 seconds – With batteries (alkaline manganese): 900 measurements – With rechargeable batteries (2000 mAh): 850 measurements
Safety shutdown	If supply voltage is too low, the instrument is switched off, or cannot be switched on. When the rotary switch is set to the OFF position, the instrument is completely disconnected from the batteries (after approximately 10 seconds).

Electromagnetic Compatibility (EMC)

Interference emission	EN 61326-1:2013 class B
Interference immunity	EN 61326-1:2013

Ambient Conditions

Accuracy	
temperature range	0 ... +40 °C
Operating temperature	-10 ... +50 °C
Storage temp. range	-25 ... +70 °C (without batteries)
Relative humidity	Up to 75% (max. 85% during storage/transport), no condensation allowed
Elevation	Max. 2000 m
Calibration interval	1 year (recommended)

Mechanical Design

Dimensions	225 x 130 x 140 mm
Weight	Approx. 1.4 kg with batteries
Protection	Housing: IP 52, measurement cables and connectors: IP 40 per DIN VDE 0470, part 1 / EN 60529, housing category 2

Extract from table on the meaning of IP codes

IP XY (1 st digit X)	Protection Against Foreign Object Entry	IP XY (2 nd digit Y)	Protection Against Penetration by Water
2	≥ 12.5 mm dia.	2	Dripping (at 15° angle)
3	≥ 2.5 mm dia.	3	Spraying water
4	≥ 1.0 mm dia.	4	Splashing water
5	Dust protected	5	Jet-water
6	Dust-proof	6	Powerful water jets

Displays

Digital display

With additional bar graph or pointer depending on selection with *R.d*, *5P* parameter, backlit (transflective); leading zeros can be suppressed at the digital display depending on *D.d*, *5P* parameter; overranging indicated with *DL* at display; dimensions: 65 x 36 mm

Limit LED



LED

LED lights up red to indicate that the measuring range has been exceeded or fallen below of.

LED lights up red to indicate:

- the presence of an **external voltage** before ESD testing (U > 50 V) with the device switched on
- the presence of the **test/measuring voltage** during (ESD) measurement (U > 50 V) the presence of a **residual voltage** after ESD testing (U > 50 V) with the device switched on or off

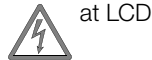

at LCD

Detection of external voltage at the LCD with the device switched on where U DC > 50 V and U AC > 40 V (50 Hz) for all measuring functions

Display Values in Consideration of Measuring Uncertainty

Table for determining minimum display values for ESD resistance in consideration of the instrument's measuring uncertainty.

Limit Value	Minimum Display Value	Limit Value	Minimum Display Value
020 kΩ	025 kΩ		
100 kΩ	111 kΩ	100 MΩ	111 MΩ
200 kΩ	219 kΩ	200 MΩ	219 MΩ
500 kΩ	541 kΩ	500 MΩ	541 MΩ
0.20 MΩ	0.25 MΩ		
0.50 MΩ	0.57 MΩ		
1.00 MΩ	1.11 MΩ	1.00 GΩ	1.11 GΩ
2.00 MΩ	2.19 MΩ	2.00 GΩ	2.19 GΩ
5.00 MΩ	5.41 MΩ	5.00 GΩ	5.41 GΩ
10.0 MΩ	11.1 MΩ	10.0 GΩ	11.1 GΩ
20.0 MΩ	21.9 MΩ	20.0 GΩ	22.6 GΩ
50.0 MΩ	54.1 MΩ	50.0 GΩ	55.9 GΩ

Table for determining maximum display values for low-value resistance in consideration of the instrument's measuring uncertainty.

Limit Value	Maximum Display Value	Limit Value	Maximum Display Value
0.15 Ω	0.11 Ω		
0.20 Ω	0.16 Ω	5.00 Ω	4.72 Ω
0.50 Ω	0.44 Ω	10.0 Ω	9.47 Ω
1.00 Ω	0.92 Ω	20.0 Ω	17.7 Ω
2.00 Ω	1.87 Ω	50.0 Ω	44.7 Ω

Voltage at Device Under Test During ESD Resistance Measurement

Measuring voltage U_x at the device under test depending upon its resistance R_x at nominal voltage $U_M = 10, 100$ and 500 V:

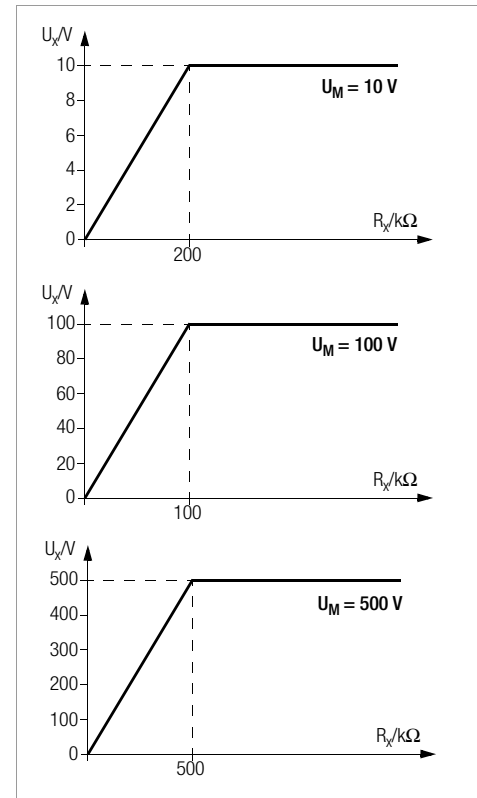

Figure 1: Characteristic Curves, $U_x(R_x)$

9 List of Abbreviations and their Meanings

Voltage

UESD	Test voltage or nominal voltage
U AC/DC	Measured voltage (sinusoidal alternating voltage)

Resistance

RESD	Insulation resistance
------	-----------------------

Fuse

FUSE	“Blown fuse” message
------	----------------------

10 Maintenance

10.1 Battery and Rechargeable Battery Operation

When only one filled segment remains in the battery symbol, install a new set of batteries or charge the rechargeable batteries. Check to make sure that no leakage has occurred at batteries or rechargeable batteries at short, regular intervals, or after the instrument has been in storage for a lengthy period of time.



Note

Prior to lengthy periods of rest (e. g. holiday), we recommend removing the (rechargeable) batteries. This helps to prevent excessive depletion or leakage of batteries, which, under unfavourable circumstances, may cause damage to the instrument.

If leakage has occurred, the electrolyte must be carefully and completely removed with a damp cloth before installing new batteries.

Replacing the Batteries

See section 3.2 and section 10.3.

10.2 Fuses

If a fuse has blown due to overload, a corresponding message error appears at the LCD panel. The instrument's voltage measuring ranges are nevertheless still functional.

10.2.1 Fuse Link – FUSE Message

This fuse is active in all resistance measuring ranges except for voltage measurement. A replacement fuse is included in the battery compartment (FF315mA/1000V).



Attention!

Disconnect the instrument from the measuring circuit before opening the battery compartment lid in order to replace the fuse (refer to page 5 for location)!

Checking the Fuse

If a resistance measuring range is selected with the rotary switch with a blown or defective fuse in the instrument, and if the instrument is turned on with the switch in this position, *FUSE* appears at the LCD. Prerequisite: The + and **COM** measurement jacks are not short circuited.

After eliminating the cause of error and replacing the defective fuse, the *FUSE* message is cleared after the instrument has once again been switched on.



Attention!

Severe damage to the instrument may occur if incorrect fuses are used.

Short-circuiting of fuse terminals or the repair of fuses is prohibited!

The instrument may be damaged if fuses with incorrect ampere ratings, breaking capacities or blowing characteristics are used!

Replacing the Fuse

- ⇨ Open the battery compartment lid by loosening the two screws.
- ⇨ Remove the defective fuse and insert a new one. A replacement fuse is included in the battery compartment.
- ⇨ Insert the new fuse.
- ⇨ Replace the battery compartment lid and retighten the screws.

10.2.2 Electronic Fuse

This fuse protects resistance measurements (switch position Ω) from overloading (electronic hardware circuit).

„**EL.Fu**“ appears when the fuse blows.

- ⇨ Eliminate the cause of overloading. This error message must be cleared by switching to **OFF** position.

10.3 Housing

No special maintenance is required for the housing. Keep outside surfaces clean. Use a slightly dampened cloth or a plastic cleaner for cleaning. Avoid the use of cleansers, abrasives or solvents.

Return and Environmentally Sound Disposal

The **instrument** is a category 9 product (monitoring and control instrument) in accordance with ElektroG (German electrical and electronic device law). This device is subject to the RoHS directive.

We identify our electrical and electronic devices in accordance with WEEE 2012/19/EU and ElektroG using the symbol shown at the right per DIN EN 50419.



These devices may not be disposed of with the trash.

Please contact our service department regarding the return of old devices.

If you use **batteries** or **rechargeable batteries** in your instrument or accessories which no longer function properly, they must be duly disposed of in compliance with the applicable national regulations.

Batteries or rechargeable batteries may contain harmful substances or heavy metal such as lead (Pb), cadmium (Cd) or mercury (Hg).

The symbol shown to the right indicates that batteries or rechargeable batteries may not be disposed of with the trash, but must be delivered to collection points specially provided for this purpose.



Pb Cd Hg

11 Appendix

11.1 Attaching the strap to the test instrument

Feed the strap through from the front of the test instrument and secure it with the slotted screw (M3).

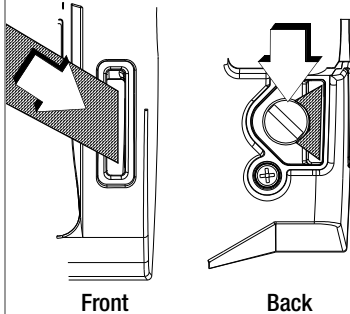

11.2 Attaching the Test Probe Holder to the Carrying Strap

- 1 Detach the strap from the instrument:
Turn out the slotted screw (M3) at the bottom.

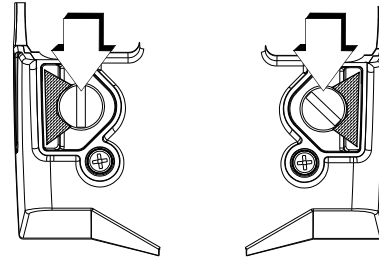

Bottom Left

Bottom Right

- ② Slide the strap through the test probe holder.

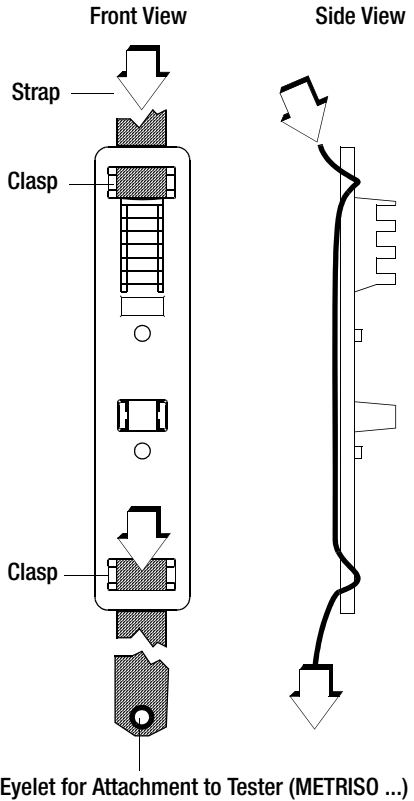

- ③ Feed the strap through from the front of the test instrument and secure it with the slotted screw (M3).

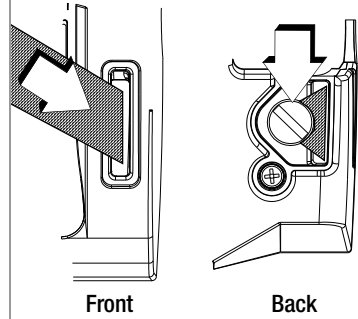

11.3 Technical Data for Measurement Cables (scope of delivery: KS17-4 safety cable set)

Electrical Safety

Maximum rated voltage	600 V	1000 V	1000 V
Measuring category	CAT IV	CAT III	CAT II
Max. rated current:	1 A	1 A	16 A
With safety cap attached	•	•	—
Without safety cap	—	—	•

Ambient Conditions (EN 61010-031)

Temperature	-20 °C ... + 50 °C
Relative humidity	Max. 80%
Pollution degree	2

Using the KS17-4



Attention!

Observe the instrument's maximum values for electrical safety. Measurements per DIN EN 61010-031 may only be performed in environments in accordance with measuring categories III and IV with the safety cap attached to the test probe at the end of the measurement cable.

In order to establish contact inside 4 mm jacks, the safety caps have to be removed by prying open the snap fastener with a pointed object (e.g. the other test probe).

Edited in Germany • Subject to change without notice

Wolfgang Warmbier GmbH & Co. KG
Systeme gegen Elektrostatik
Untere Gießwiesen 21
78247 Hilzingen • Germany

Phone +49 77 31 86 88-0
Fax +49 77 31 86 88-30
E-Mail info@warmbier.com
www.warmbier.com

